

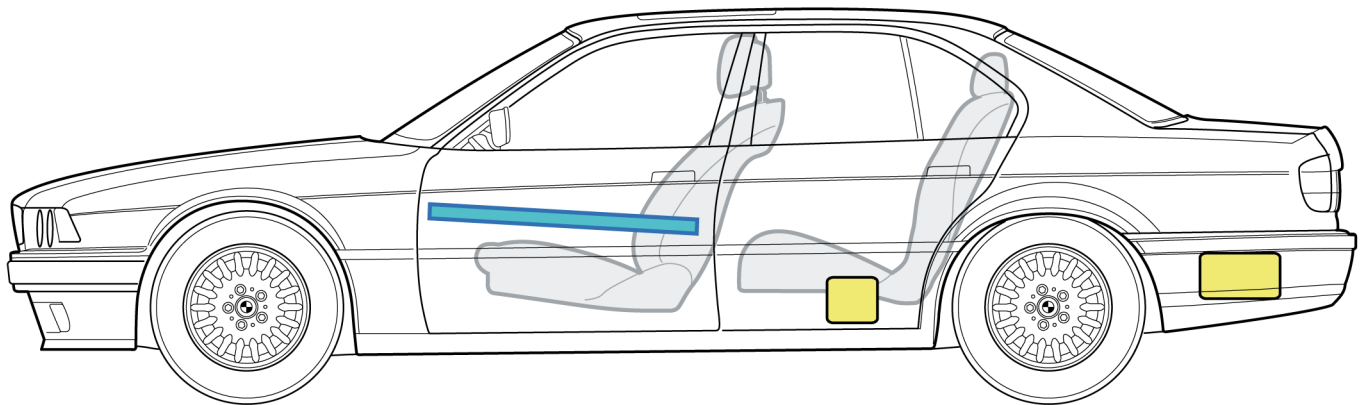

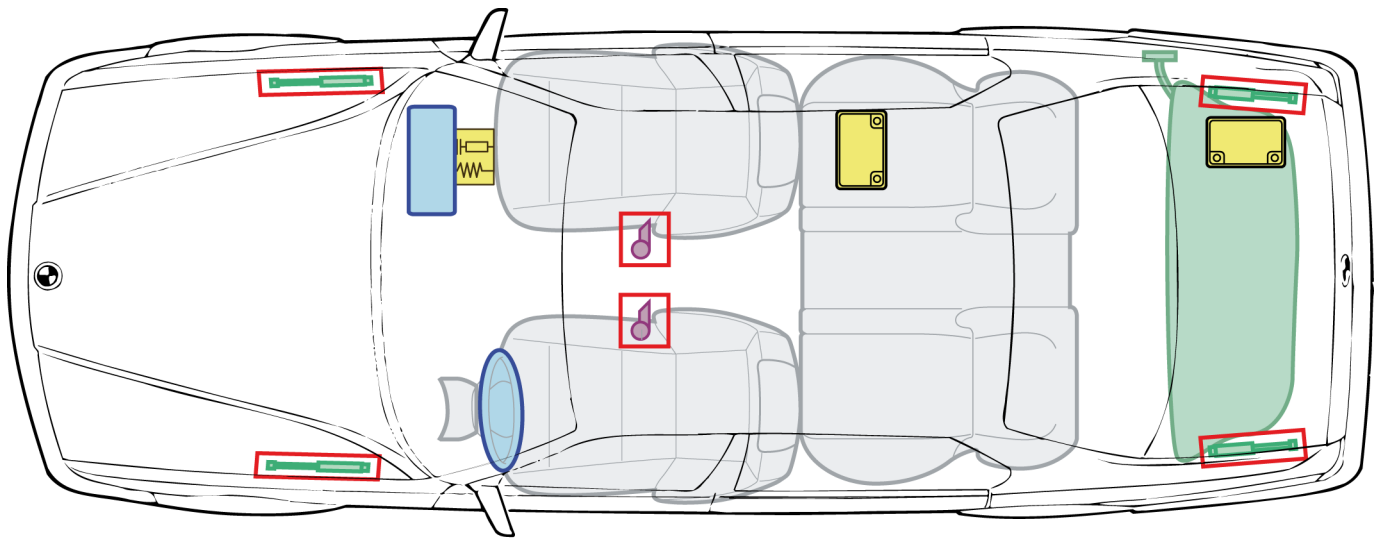



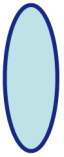

7-Series E32

(06/1986–08/1994)



Legend

	Airbag		Body reinforcement		Airbag control unit
	Belt tensioner		Gas-filled shock absorber		12 V battery
	Fuel tank				

This overview shows the maximum possible vehicle equipment.

Opening the vehicle

These notes apply exclusively to trained emergency service personnel. Knowledge of the function and operating principle of the safety systems and vehicle characteristics is also needed.

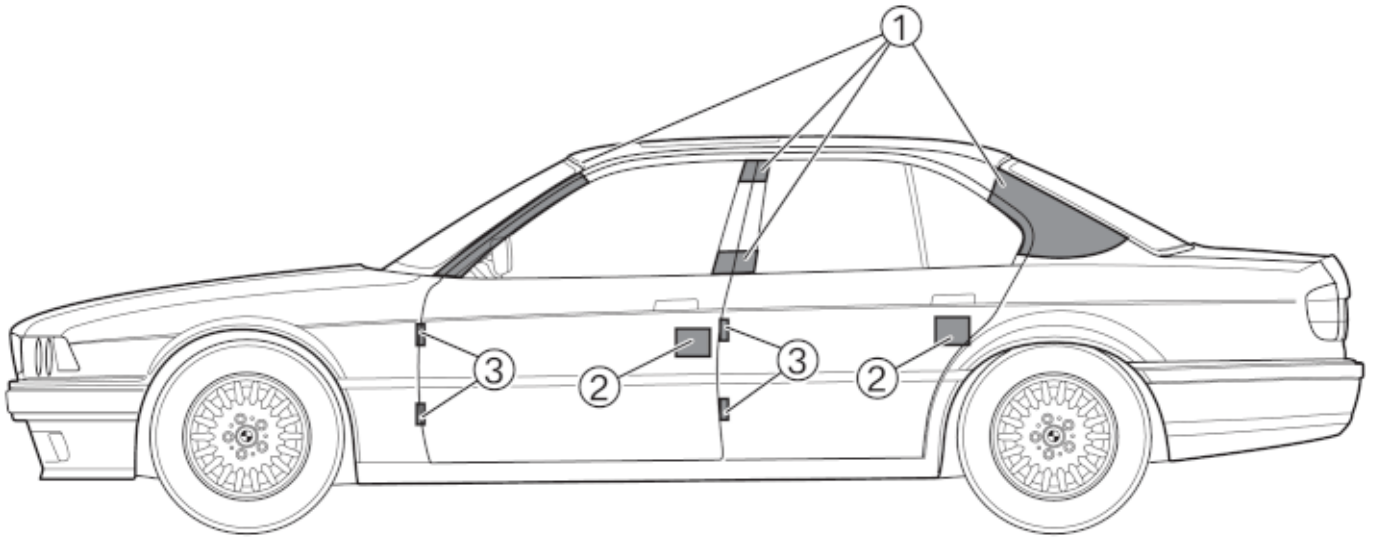

1. The areas mark the zones at which the roof can be cut off. Modern heavy duty cutting equipment is mandatory for cutting the body. Older hydraulic cutting tools could be overloaded.

The heavy duty cutting equipment must be properly used by trained and qualified personnel.

2. Door locks
3. Door hinges

Important information

The information for emergency services must be followed, see rescue manual.